

产品图 Product drawing

版本 REV	日期 DATE	变更内容 CHANGE (ITEM)
A0	2025-10-24	新建 NEW

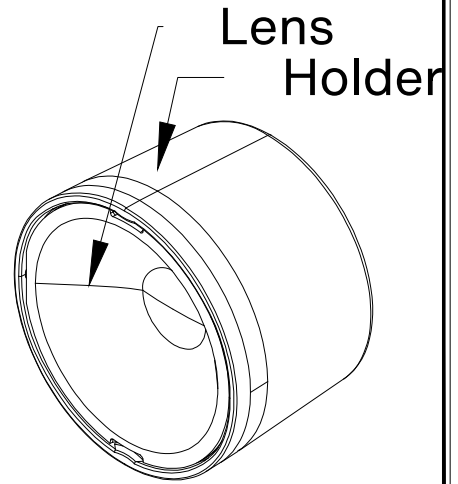
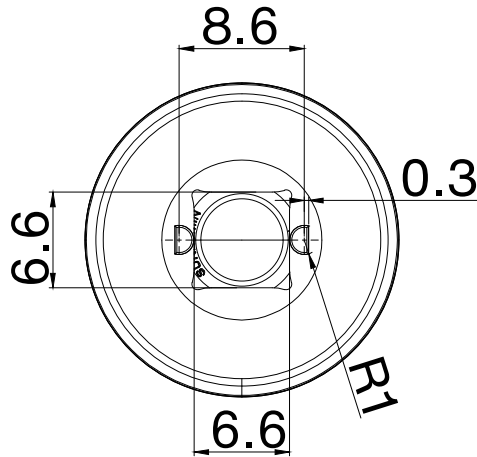
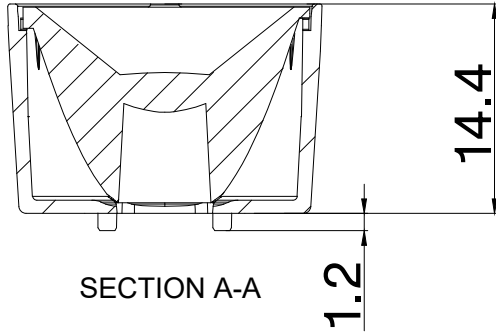
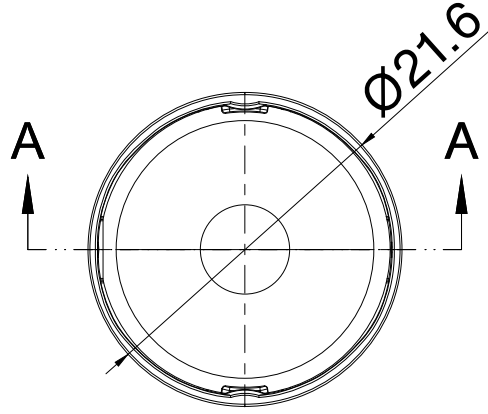

技术要求:

1. 图中有序号尺寸需要重点控制;
2. 产品不得有缺胶、气泡、收缩、黑点等异常;
3. 塑料成型的公差一般按照 GB/T14486 标准, 除非图纸另有说明。
硅胶成型的公差一般按照 ISO 3302-1 中的 M3 级, 除非图纸另有说明。

Technical requirements:

1. The size of the ordered number in the figure needs to be controlled;
2. The product shall not have lack of glue, bubbles, shrinkage, black spots and other abnormalities;
3. Plastic moulding general tolerances according to GB/T14486 and applies if not otherwise shown in the drawing. Silicone moulding general tolerances according to ISO 3302-1 Class M3 and applies if not otherwise shown in the drawing.

SUNLUMIN OPTICS CO.,LTD

产品名称 Item name	S01.01.02.440_ HILBERT-36_G2_5050-PIN	产品材质 Product material	Lens:PMMA Holder:PC
图法 View	第三视角	设计 Designed by	YeJingsi
比例 Scale	1:1	审核 Checked by	Eric
单位 Unit	MM	批核 Approved by	Eric