

DATASHEET

S01.01.01.249_MAXWELL-6-T5

Street & Area Lighting:

IESNA Type V beam.

MAXWELL-6 SERIES, 50 x 50 mm 2X3 arrays for flat 5050 size LED packages.

Beam for area and street lighting such as parks and pedestrian walkways.

General Information

Lens Material	: Optical PC
Size	: 50X50mm
Typ.FWHM	: 140° x140°
Design LED	: LUXEON 5050 Square
Compatibility	: 2835/3030/3535/5050
typ.Efficiency	: 92%
Fasten	: Screw
IP class	: N/A
Zhaga	: N/A
RoHS	: YES
Color	: Clear



产品图 Product drawing

版本 REV	日期 DATE	变更内容 CHANGE (ITEM)
A0	2026-4-22	新建 NEW

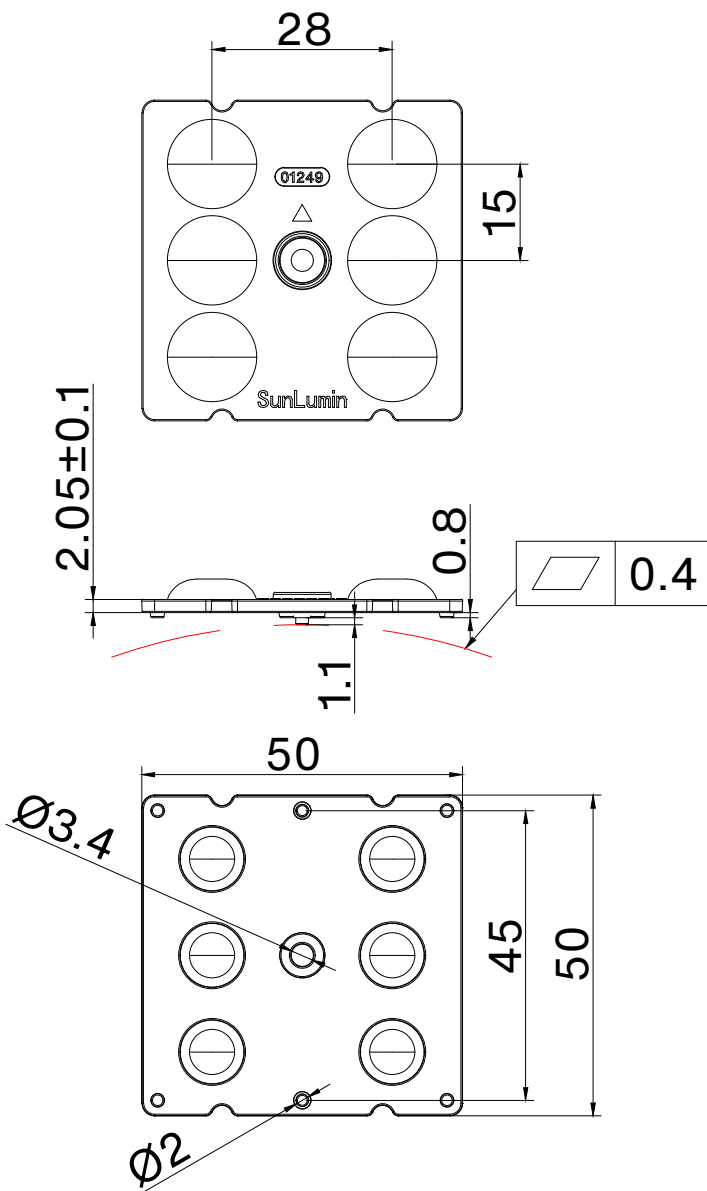

技术要求:

1. 图中有序号尺寸需要重点控制;
2. 产品不得有缺胶、气泡、收缩、黑点等异常;
3. 塑料成型的公差一般按照 GB/T14486 标准, 除非图纸另有说明。
硅橡胶成型的公差一般按照 ISO 3302-1 中的 M3 级, 除非图纸另有说明。

Technical requirements:

1. The size of the ordered number in the figure needs to be controlled;
2. The product shall not have lack of glue, bubbles, shrinkage, black spots and other abnormalities;
3. Plastic moulding general tolerances according to GB/T14486 and applies if not otherwise shown in the drawing. Silicone moulding general tolerances according to ISO 3302-1 Class M3 and applies if not otherwise shown in the drawing.

产品名称 Item name	S01.01.01.249_ MAXWELL-6-T5	产品材质 Product material	PC
图法 View	第三视角	设计 Designed by	Hay
比例 Scale	1:1	审核 Checked by	Eric
单位 Unit	MM	批核 Approved by	Eric

SUNLUMIN OPTICS CO.,LTD

OPTICAL RESULTS

1) PHOTOMETRIC DATA(MEASURED):



LED model	LUXEON 5050 Square
Light colour	White
LEDs/each optic	1
FWHM	H138.6,V142.7
FWTM	H151.6,V154.8
Required components:	

Glass

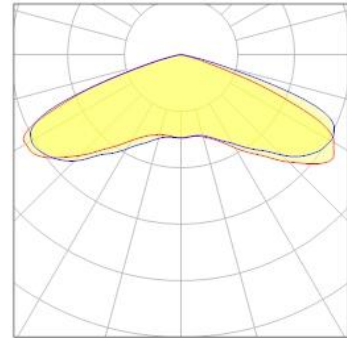

2) PHOTOMETRIC DATA(SIMULATED):



LED model	GW_P9LR35pm
Light colour	White
LEDs/each optic	1
FWHM	H140.2,V144.6
FWTM	H155.5,V159
Required components:	

Glass

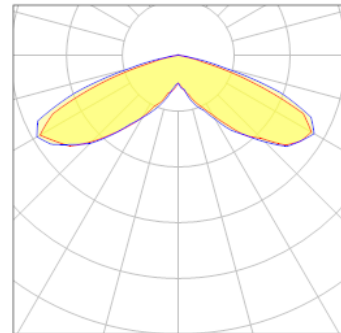

3) PHOTOMETRIC DATA(SIMULATED):



LED model	JR5050 Square 6V
Light colour	White
LEDs/each optic	1
FWHM	H138.3,V144
FWTM	H153.9,V158.3
Required components:	

Required components:

SUNLUMIN OPTICS CO.,LTD

Glass

address:
Shenzhen, Guangdong Province, China

E
info@sunlumin-optics.com

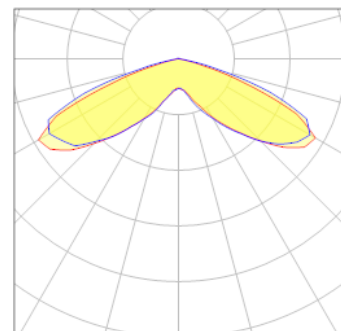

www.
sunlumin-optics.com

Usage and Maintenance

1) Due to varying asymmetric chip locations, especially on mid-power LEDs, the exact source of light is not always located at the centre of the LED packet. SunLumin recommends rotating such LEDs on the PCB in a regular pattern for smoother results.

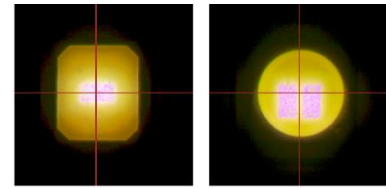

Sample layout proposal:

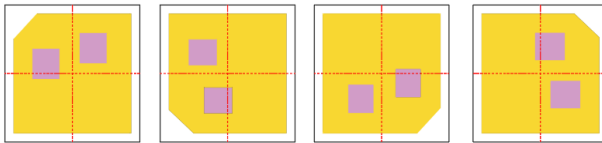

Example A

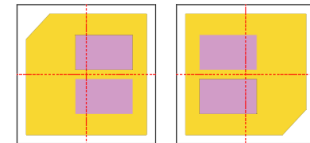

Example B

- 2) If necessary, clean lenses with mild soap, water and soft cloth.
- 3) Never use any commercial cleaning solvents on lenses, like alcohol.
- 4) Please handle lens with wearing gloves, skin oils may damage lens or its optical characteristic.

Disclaimer

When gule pass through holes, columns and other structures, or part of the thin structure, will form a weld line. Please note that flow lines and weld lines on the external surfaces of the lenses are acceptable if the optical performance of the lens is within the specifications.

The typical beam angle will be changed by different color, chip size and chip position tolerance. The typical total beam angle is the full angle measured where the luminous intensity is half of the peak value. The chart data is for reference only. Please test the data again before using.

The appearance and specifications of the product can be changed to improve the quality and/or performance without notice.

SunLumin assumes no liability of any kind for the possible deviation from any provided data or any other damage resulting from the usage of the provided data.

Last update: 8-May-26